

The portable, patented and high security way to secure container doors

Overview

External portable locks. Installed in few seconds.
NFC Key: turn any smartphone into a unique traceable digital key.

Bracket lock: 2 locking points. The highest security,
Light weight, locking over brackets and vertical bars.

Specifically designed for shipping container doors

Technical Specifications

	Bracket lock
Net weight:	7 kg
Lock dimensions:	470 x 180 x 80 - Closed 530 x 180 x 80 - Fully extended
Gross weight:	8 KG
Package size:	540 x 190 x 90

Body 5mm steel.
Electrophoretic Paint Coatings: high corrosion resistance.

Lithium Ion Battery: -40°C / +60°C ; 6.000 cycles.
Heavy duty battery version available: -60 °C / +85 °C.
Built in cavity for 3rd party GPS integration.

HS Code: 8301.40.90.00
EXW: Johannesburg (South Africa).

Installation

A portable container lock. Place the lock on the brackets of the vertical bars and activate the NFC. Locked in under a minute.
No tools needed.

Cut it in half? Good luck!

Impossible to break or remove even if vertical bars are cut!

Why Seguratainer

- ✓ A new generation of patented high security locks
- ✓ NFC Keyless technology: your phone is the key
- ✓ Full control of your fleet from your laptop
- ✓ 24/7 history of each lock

A full locking and management system.



Bracket lock

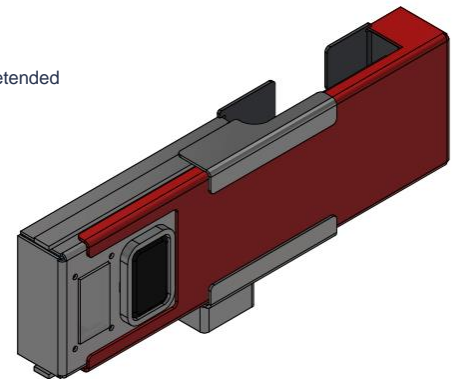

Bracket lock fully extended

How it works

Seguratainer locks are part of a **full locking and management system** which includes the Seguratainer Management Platform and the Seguratainer Mobile App (Digital Key).



High Security Locks for Shipping Containers and Closed Body Trucks

MANAGEMENT PLATFORM

Full control of your fleet and locks from your laptop

Overview

No installation: browser based.
Create unique digital keys for your team in seconds.
 Manage locks, users and roles from your laptop.
 Access each lock 24/7 history.
 One licensing fee with no limitation of users or devices.

Full control of your locks and fleets from your laptop

Full Control

Modify any parameter from your laptop.
 Grant or deny access to personnel in seconds.
 Full audit trail records for each lock.
 Each digital key assigned to one person only.
 Create time and geolocation rules to restrict lock access.

Customization and Integration

Customize the platform to fit your specific needs.
 API integration with your existing databases and platform.
 Expandable as a white labelled cloud based fleet management hub.

Seguratainer Management Platform provides a state of the art and flexible fleet control toolkit that you can customize, import into your existing system or adopt on its own.

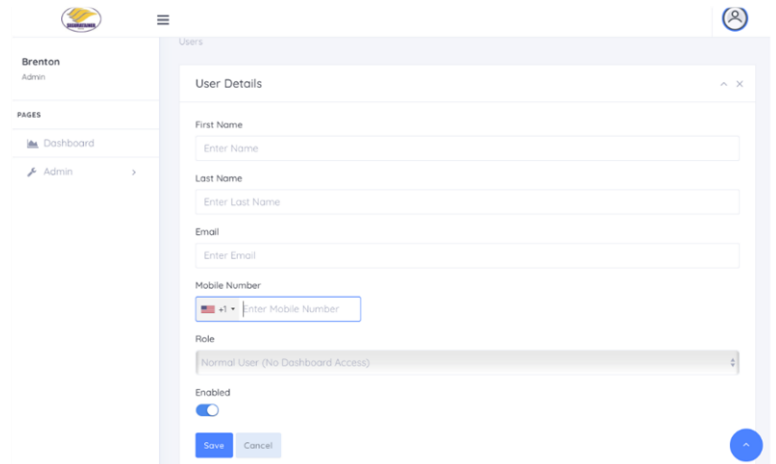

Screenshot: adding a user

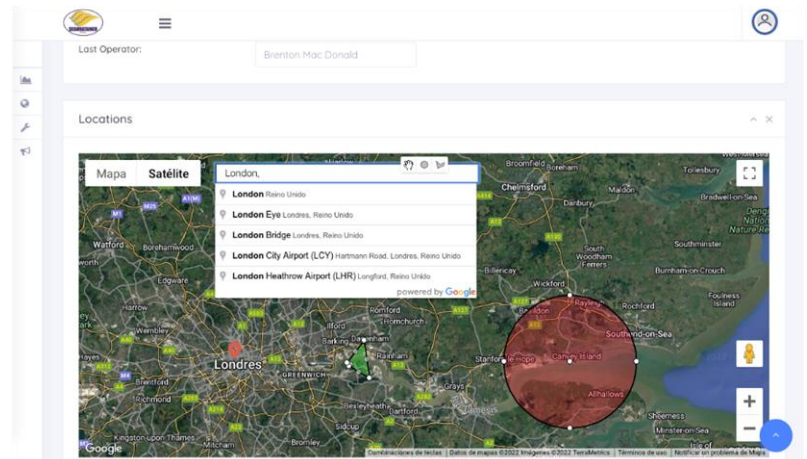

Screenshot: setting geolocation rules

Why Seguratainer

- ✓ A new generation of patented high security locks
- ✓ NFC Keyless technology: your phone is the key
- ✓ Full control of your fleet from your laptop
- ✓ 24/7 history of each lock

A full locking and management system.

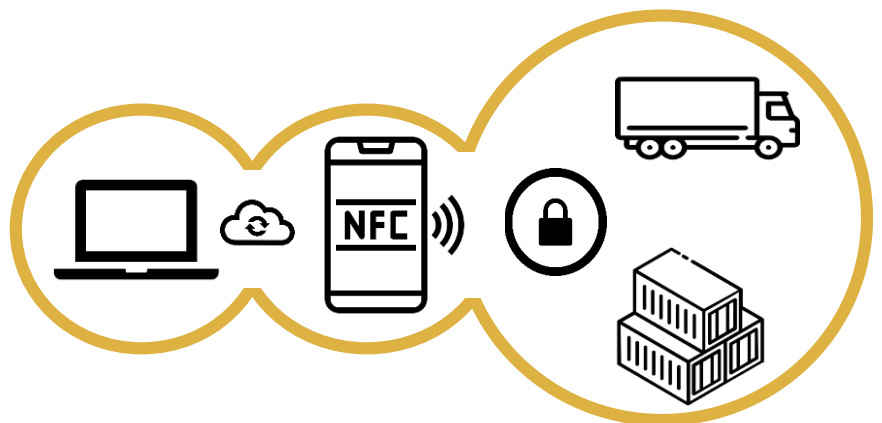

High Security Locks for Shipping Containers and Closed Body Trucks

MOBILE APP (NFC DIGITAL KEY)

The Safest Access Control with 24/7 Trail Record

Why NFC?

NFC (near-field communication) limits the connection short distances (1 cm).

No anonymous openings, no remote malicious signal theft.

NFC and Seguratainer's purpose-built encryption gives you convenience and security.

Your smartphone is the key!

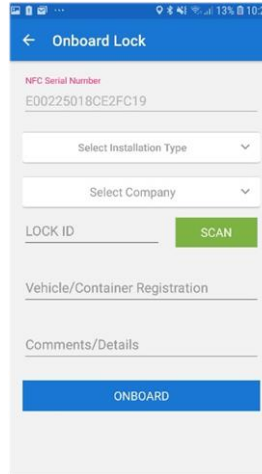

Onboarding a new lock

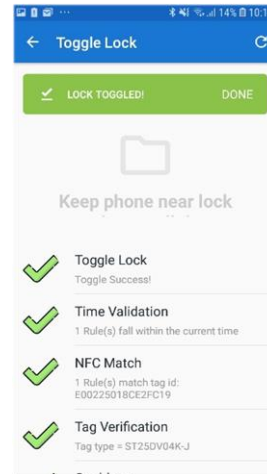

Access to lock: OK

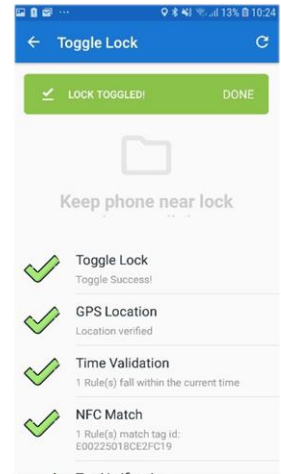

Access to lock with Geolocation: OK

Full Control

1 app user = 1 identifiable person. No anonymous access. Every action is registered (lock activation or attempt). NFC Access Control activates open the lock. High security: 256-bit encryption. App syncs lock and platform to your latest modifications. NFC does not require GSM data to activate the lock.

The free Seguratainer Mobile App provides the safest touchless opening technology (NFC) and immediate data (to Management Platform).

Seguratainer keys cannot be copied, broken or lost. 1 key = 1 person. No anonymous access.

Free Installation

Available for free on Android (iOS: Q3 2023). No pay-per-use: unlimited usage. No pay-per-key: as many keys as you need. User friendly and fast.

How it works

1. Open the Mobile App (updates data from Management Platform).
2. Place the phone within 1 cm from the lock.
3. App and lock verify the credentials (5 seconds).
4. Access granted or Access denied.
5. App sends back the data to Management Platform.

Why Seguratainer

- ✓ A new generation of patented high security locks
- ✓ NFC Keyless technology: your phone is the key
- ✓ Full control of your fleet from your laptop
- ✓ 24/7 history of each lock

A full locking and management system.



High Security Locks for Shipping Containers and Closed Body Trucks